

## Spezifikation

- mehrstufige Kreiselpumpe in Mantelbauweise mit **oddesse** Tauchmotor
- Druckabgang mit integriertem Rückschlagventil
- Antrieb durch Drehstrom-Motoren
- minimale Wasserüberdeckung des Pumpenaggregates 2 m
- min. Strömungsgeschwindigkeit entlang des Motors 0.5 m/s, max. Temperatur des Mediums von 30 °C
- reines, sauberes Wasser mit festen Beimengungen bis max. 50 mg/l
- Standardanschluss: R = G3 (Rohrgewinde nach DIN ISO 228 Teil 1)
- andere Anschlüsse als Zubehör lieferbar
- Abnahme nach DIN EN ISO 9906 Klasse 2
- Sonderausführungen (Horizontaleinsatz usw.) auf Anfrage
- Mindesteffizienzindex MEI  $\geq 0.4$

## Hauptabmessungen

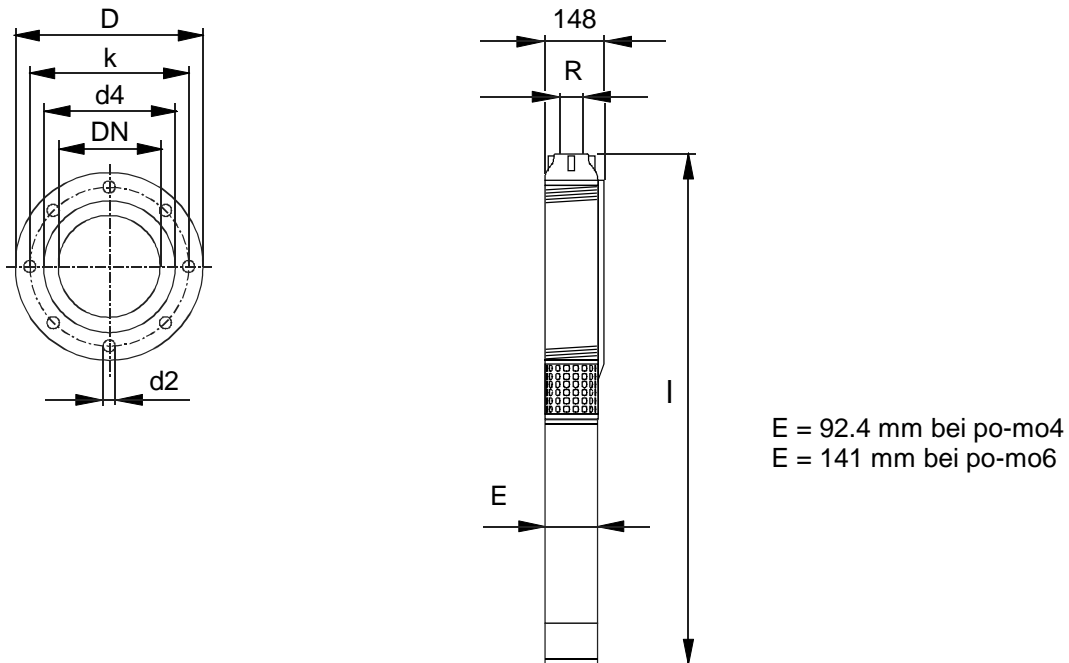

## Anschlussmaße für Adapter und Übergänge

Type	Reduzierung Gewinde	Adapter						
		Gewinde $\Rightarrow$ Flansch	Abmessungen					
			D [mm]	b [mm]	k [mm]	d4 [mm]	d2 [mm]	m [kg]
po-so-10/6.5 po-so-16/6.5 po-so-25/6.5 po-so-40/6.5 po-so-63/6.5	G3 $\Rightarrow$ G2	G3 $\Rightarrow$ DN50, PN16	165	18	125	102	4x $\varnothing$ 18	3.5
		G3 $\Rightarrow$ DN50, PN40	165	20	125	102	4x $\varnothing$ 18	3.7
		G3 $\Rightarrow$ DN65, PN16	185	18	145	122	4x $\varnothing$ 18	4.1
		G3 $\Rightarrow$ DN65, PN40	185	22	145	122	8x $\varnothing$ 18	4.3
		G3 $\Rightarrow$ DN80, PN16	200	20	160	138	8x $\varnothing$ 18	4.7
		G3 $\Rightarrow$ DN80, PN40	200	24	160	138	8x $\varnothing$ 18	5.7
		G3 $\Rightarrow$ DN100, PN16	220	20	180	158	8x $\varnothing$ 18	6.1
		G3 $\Rightarrow$ DN100, PN40	235	24	190	162	8x $\varnothing$ 22	8.0

Flanschabmessungen nach DIN 2633 (PN16) und DIN 2635 (PN40)

Materialausführung verzinkt oder Edelstahl

PN Nenndruck [bar], DN Nenndurchmesser [mm], b Flanschdicke [mm], m Masse [kg]

Flansche mit je 2 Kabelaussparungen

Änderungen vorbehalten

## Konstruktionsmaterialien

### Tauchmotorpumpen po-so/6.5

Komponente	Ausführung
	Standard-Version
Laufrad	Noryl / GFN3
Leitapparat, Stufengehäuse	Noryl / GFN3
Einlaufstück, RV-Gehäuse	Edelstahl / 1.4301
Radiallager	Bronze / Messing, keramikbeschichtet
Pumpenmantel	Edelstahl / 1.4301
Einlaufsieb	Edelstahl / 1.4301
Kupplung	Edelstahl / 1.4005
Welle	Edelstahl / 1.4021
Schrauben, Muttern, Bolzen	Edelstahl 1.4301 / 1.4303
Motor	siehe Abschnitt Tauchmotoren

### Anmerkung:

Der Mindesteffizienzindex (MEI) bezieht sich auf den vollen Laufraddurchmesser. Alle Pumpen dieser Serie gelangen werksseitig ausschließlich mit vollem Laufrad zur Auslieferung.

Durch eine Korrektur des Laufrades kann die Pumpe einem bestimmtem Betriebspunkt angepasst werden, wodurch sich der Energieverbrauch verringert. Der Wirkungsgrad einer Pumpe mit korrigiertem Laufrad ist gewöhnlich niedriger als der einer Pumpe mit vollem Laufraddurchmesser.

Der Betrieb dieser Wasserpumpe bei unterschiedlichen Betriebspunkten kann effizienter und wirtschaftlicher sein, wenn sie z. B. mittels einer variablen Drehzahlsteuerung gesteuert wird, die den Pumpenbetrieb an das System anpasst.

Informationen zum Effizienzreferenzwert sind unter [www.europump.org](http://www.europump.org) abrufbar, Referenzwertkurven sind unter [www.europump.org/efficiencycharts](http://www.europump.org/efficiencycharts) verfügbar.

**po-so-10/6.5**  
2850 1/min - 50 Hz

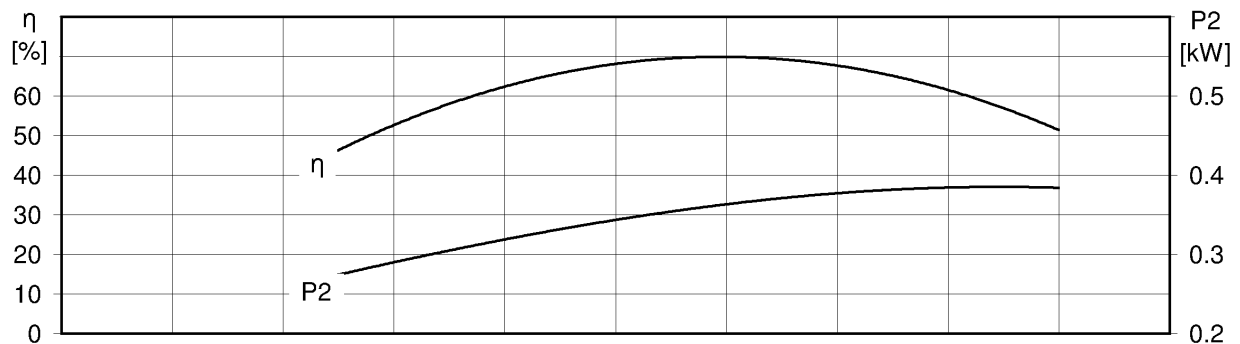
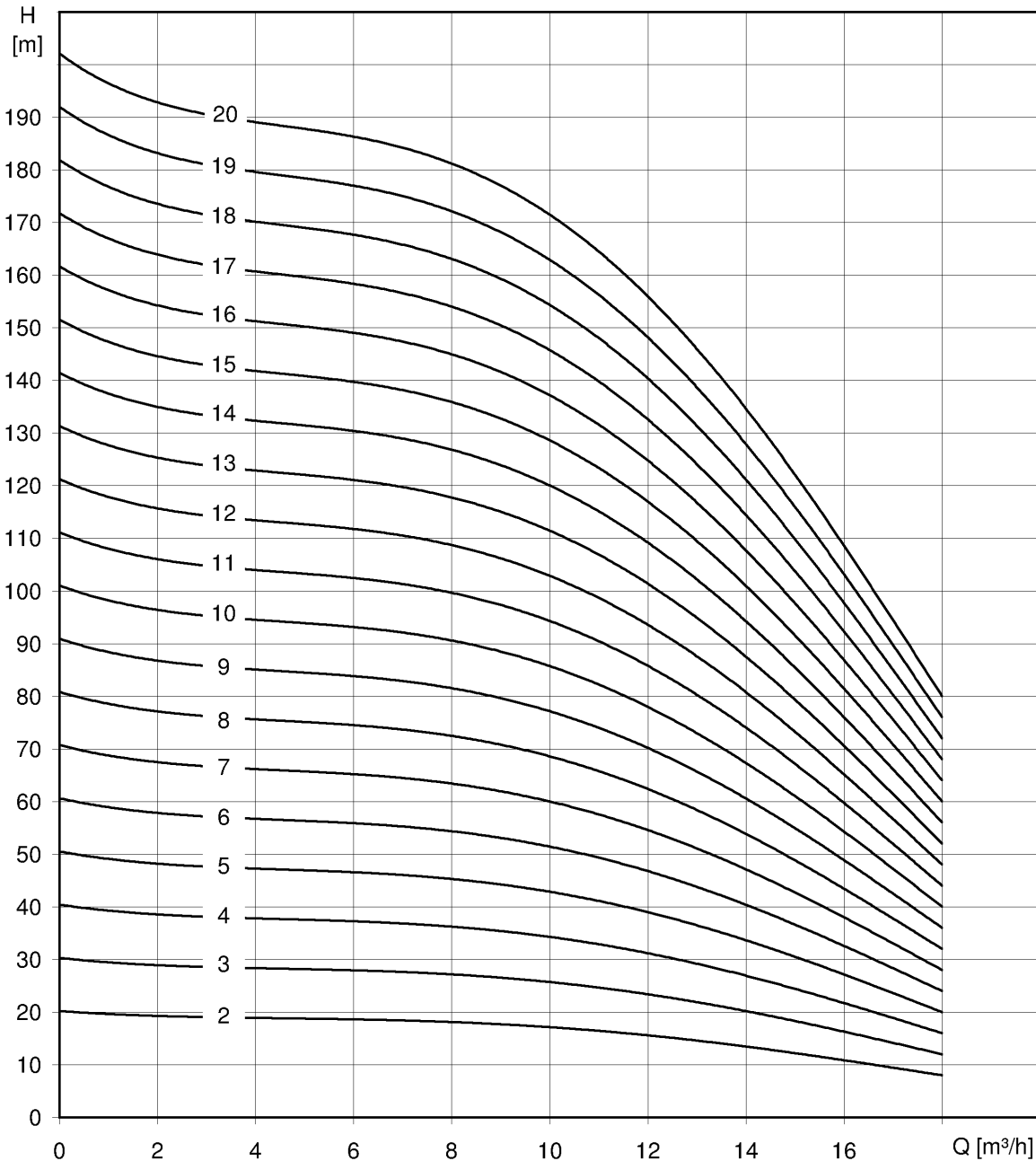

Änderungen vorbehalten

**po-so-10/6.5**  
2850 1/min - 50 Hz

Type	Leistung		Strom 400V [A]	Fördermenge Q								Länge l [mm]	Masse m [kg]	
	[kW]	[HP]		[l/s]	1.4	2.2	2.5	2.8	3.3	3.9	4.4			5.0
				[m³/h]	5	8	9	10	12	14	16			18
po-so-10- 2/6.5	1.1*	1.5*	3.4	Förderhöhe H [m]	19	18	18	17	16	13	11	8	806	16
po-so-10- 3/6.5	1.5*	2*	4.4		28	27	27	26	23	20	16	12	907	19
po-so-10- 4/6.5	2.2*	3*	5.9		38	36	35	35	31	27	22	16	991	22
po-so-10- 5/6.5	2.2*	3*	5.9		47	45	44	43	39	34	27	20	1030	23
po-so-10- 6/6.5	3*	4*	8.3		56	54	53	52	47	40	33	24	1220	30
po-so-10- 7/6.5	3*	4*	8.3		66	63	62	60	54	47	38	28	1259	31
po-so-10- 8/6.5	4*	5.5*	10		75	72	71	69	62	54	44	32	1368	35
po-so-10- 9/6.5	4*	5.5*	10		85	81	80	78	70	60	49	36	1407	36
po-so-10-10/6.5	4*	5.5*	10		94	90	89	86	78	67	55	40	1446	37
po-so-10-11/6.5	5.5*	7.5*	14		103	99	97	95	86	74	60	44	1555	42
po-so-10-12/6.5	5.5*	7.5*	14		113	108	106	104	93	81	65	48	1594	42
po-so-10-13/6.5	5.5*	7.5*	14		122	117	115	112	101	87	71	52	1633	43
po-so-10-14/6.5	5.5*	7.5*	14		132	126	124	121	109	94	76	56	1672	44
po-so-10-15/6.5	7.5	10	17		141	135	133	129	117	101	82	60	1756	66
po-so-10-16/6.5	7.5	10	17		150	144	142	138	124	107	87	64	1795	67
po-so-10-17/6.5	7.5	10	17		160	153	151	147	132	114	93	68	1834	68
po-so-10-18/6.5	7.5	10	17		169	162	159	155	140	121	98	72	1873	69
po-so-10-19/6.5	7.5	10	17		179	171	168	164	148	128	104	76	1912	70
po-so-10-20/6.5	9.2	12.5	21		188	180	177	173	156	134	109	80	1991	75

\* 4"-Motor

Mindesteffizienzindex MEI ≥ 0.4

Änderungen vorbehalten

**po-so-10/6.5**  
2850 1/min - 50 Hz

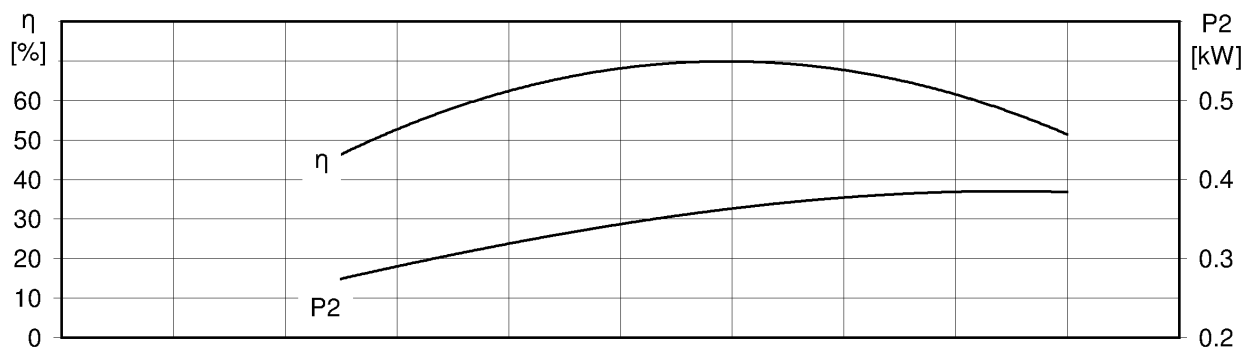
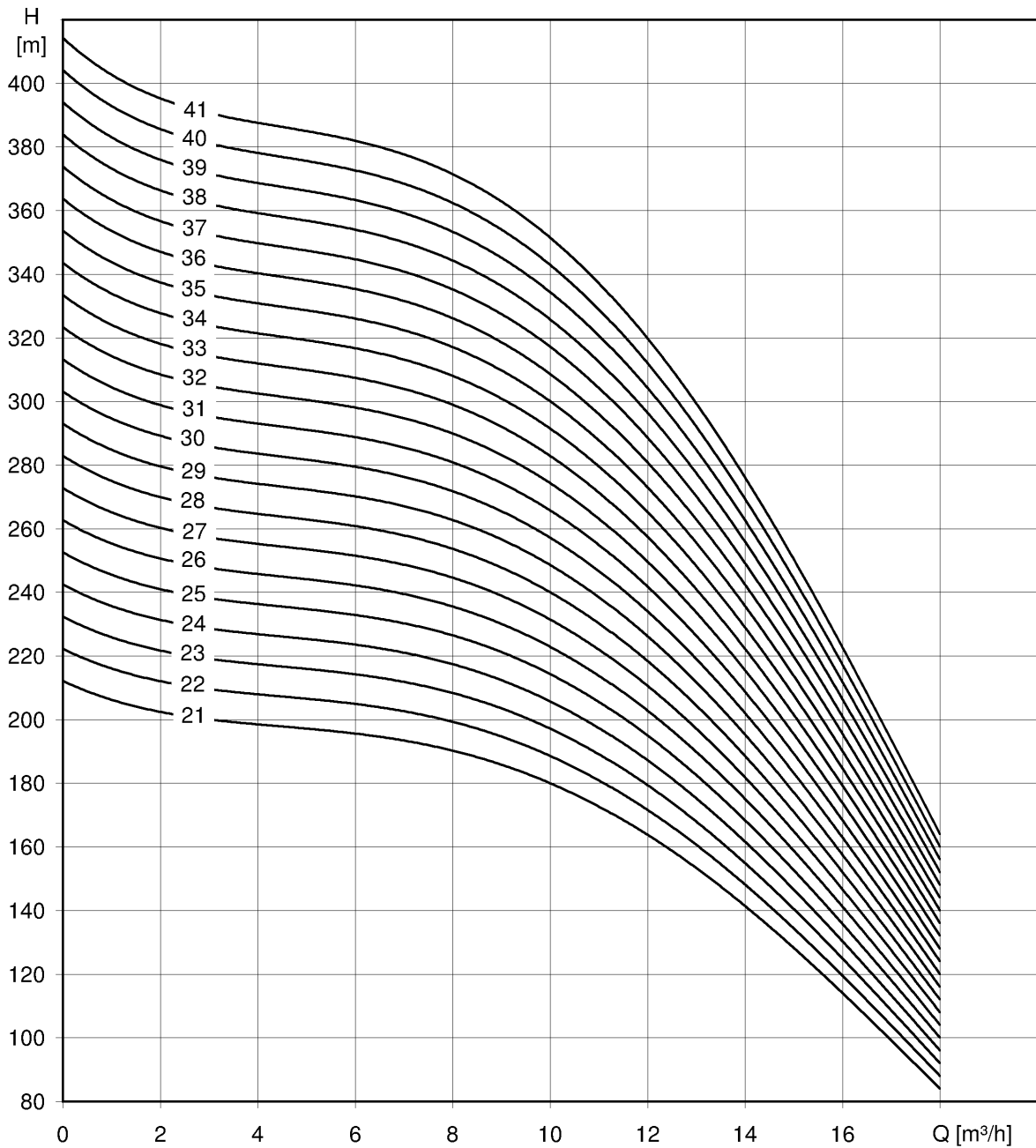

Änderungen vorbehalten

**po-so-10/6.5**  
2850 1/min - 50 Hz

Type	Leistung [kW] [HP]		Strom 400V [A]	Fördermenge Q										Länge l [mm]	Masse m [kg]
				[l/s]	1.4	2.2	2.5	2.8	3.3	3.9	4.4	5.0			
				[m³/h]	5	8	9	10	12	14	16	18			
po-so-10-21/6.5	9.2	12.5	21	Förderhöhe H [m]	197	189	186	<b>181</b>	163	141	115	84	2030	76	
po-so-10-22/6.5	9.2	12.5	21		207	198	195	<b>190</b>	171	148	120	88	2069	76	
po-so-10-23/6.5	9.2	12.5	21		216	207	204	<b>199</b>	179	154	125	92	2108	77	
po-so-10-24/6.5	11	15	24		226	216	213	<b>207</b>	187	161	131	96	2232	86	
po-so-10-25/6.5	11	15	24		235	225	221	<b>216</b>	194	168	136	100	2310	87	
po-so-10-26/6.5	11	15	24		244	234	230	<b>224</b>	202	175	142	104	2349	88	
po-so-10-27/6.5	11	15	24		254	243	239	<b>233</b>	210	181	147	108	2388	89	
po-so-10-28/6.5	11	15	24		263	252	248	<b>242</b>	218	188	153	112	2427	89	
po-so-10-29/6.5	13	17.5	29		273	261	257	<b>250</b>	226	195	158	116	2501	94	
po-so-10-30/6.5	13	17.5	29		282	270	266	<b>259</b>	233	201	164	120	2540	95	
po-so-10-31/6.5	13	17.5	29		291	279	275	<b>268</b>	241	208	169	124	2579	96	
po-so-10-32/6.5	13	17.5	29		301	289	283	<b>276</b>	249	215	174	128	2618	97	
po-so-10-33/6.5	13	17.5	29		310	298	292	<b>285</b>	257	222	180	132	2657	98	
po-so-10-34/6.5	15	20	32		320	307	301	<b>293</b>	264	228	185	136	2746	104	
po-so-10-35/6.5	15	20	32		329	316	310	<b>302</b>	272	235	191	140	2785	104	
po-so-10-36/6.5	15	20	32		338	325	319	<b>311</b>	280	242	196	144	2824	105	
po-so-10-37/6.5	15	20	32		348	334	328	<b>319</b>	288	248	202	148	2863	106	
po-so-10-38/6.5	15	20	32		357	343	337	<b>328</b>	296	255	207	152	2902	107	
po-so-10-39/6.5	18.5	25	40		367	352	345	<b>337</b>	303	262	213	156	3006	115	
po-so-10-40/6.5	18.5	25	40		376	361	354	<b>345</b>	311	269	218	160	3045	116	
po-so-10-41/6.5	18.5	25	40	385	370	363	<b>354</b>	319	275	224	164	3084	117		

Mindesteffizienzindex MEI ≥ 0.4

Änderungen vorbehalten

**po-so-16/6.5**  
2850 1/min - 50 Hz

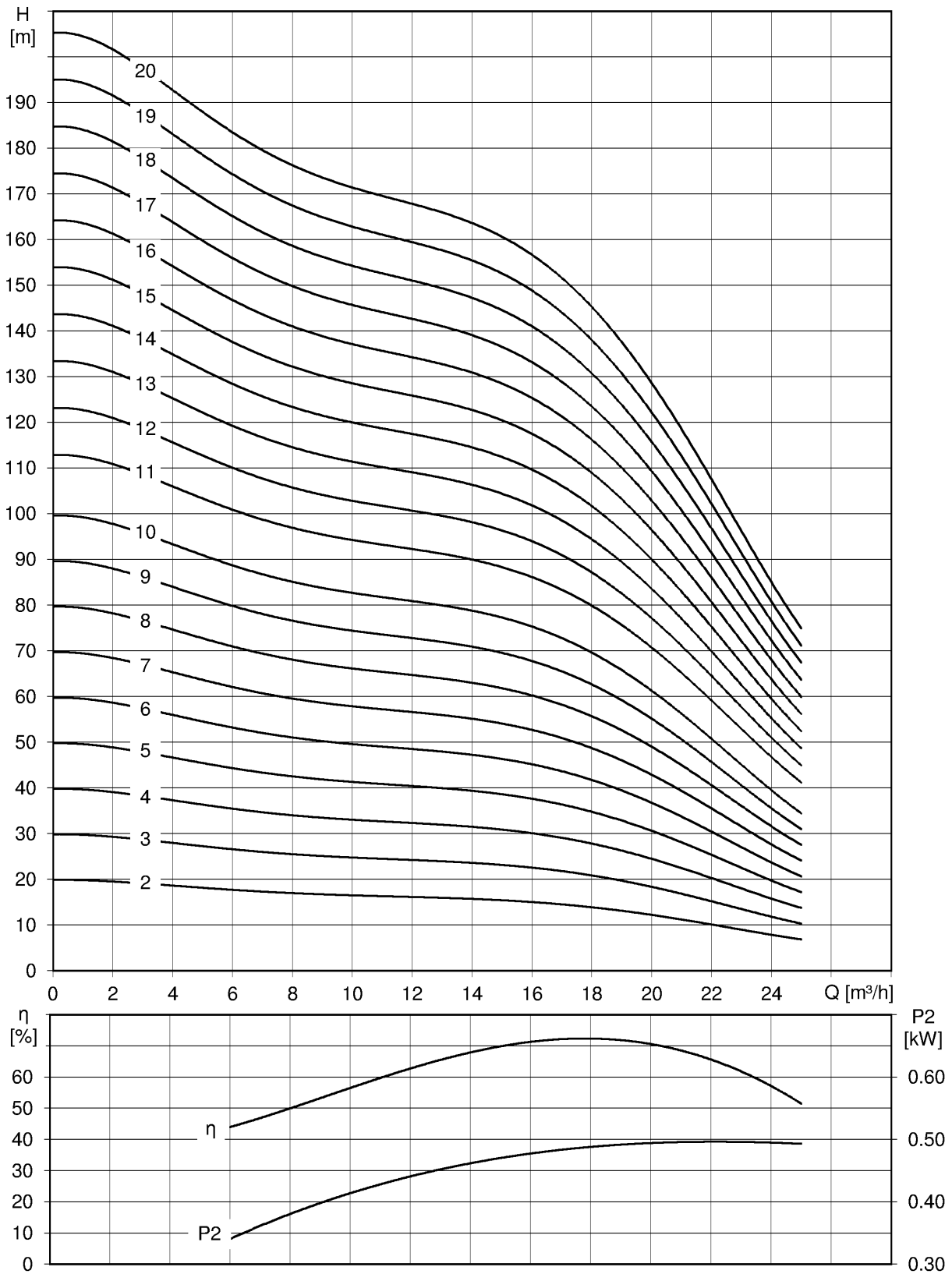

Änderungen vorbehalten

**po-so-16/6.5**  
2850 1/min - 50 Hz

Type	Leistung		Strom 400V [A]	Fördermenge Q										Länge	Masse
	[kW]	[HP]		[l/s]	1.7	2.5	3.3	4.4	4.7	5.6	6.1	6.9	l [mm]	m [kg]	
				[m³/h]	6	9	12	16	17	20	22	25			
po-so-16- 2/6.5	1.1*	1.5*	3.4	Förderhöhe H [m]	18	17	16	15	15	12	10	7	806	16	
po-so-16- 3/6.5	2.2*	3*	5.9		27	25	24	23	22	18	15	10	952	21	
po-so-16- 4/6.5	2.2*	3*	5.9		35	34	32	30	29	24	21	14	991	22	
po-so-16- 5/6.5	3*	4*	8.3		44	42	40	38	36	30	26	17	1181	30	
po-so-16- 6/6.5	4*	5.5*	10		53	50	48	46	44	36	31	21	1290	34	
po-so-16- 7/6.5	4*	5.5*	10		62	59	56	53	51	42	36	24	1329	35	
po-so-16- 8/6.5	5.5*	7.5*	14		71	67	64	61	58	48	41	28	1438	39	
po-so-16- 9/6.5	5.5*	7.5*	14		80	76	72	69	65	54	46	31	1477	40	
po-so-16-10/6.5	5.5*	7.5*	14		89	84	80	76	73	60	51	34	1516	41	
po-so-16-11/6.5	7.5	10	17		101	96	92	87	83	70	60	41	1600	63	
po-so-16-12/6.5	7.5	10	17		110	104	100	95	91	76	65	45	1639	64	
po-so-16-13/6.5	7.5	10	17		119	113	109	103	98	83	71	49	1678	65	
po-so-16-14/6.5	7.5	10	17		128	122	117	111	106	89	76	52	1717	66	
po-so-16-15/6.5	9.2	12.5	21		138	130	125	119	113	95	82	56	1796	70	
po-so-16-16/6.5	9.2	12.5	21		147	139	134	127	121	102	87	60	1835	71	
po-so-16-17/6.5	9.2	12.5	21		156	148	142	135	129	108	92	64	1874	72	
po-so-16-18/6.5	9.2	12.5	21		165	157	150	142	136	114	98	67	1913	73	
po-so-16-19/6.5	11	15	24		174	165	159	150	144	121	103	71	2037	82	
po-so-16-20/6.5	11	15	24		183	174	167	158	151	127	109	75	2076	83	

\* 4"-Motor

Mindesteffizienzindex MEI  $\geq$  0.4

Änderungen vorbehalten



**po-so-16/6.5**  
2850 1/min - 50 Hz

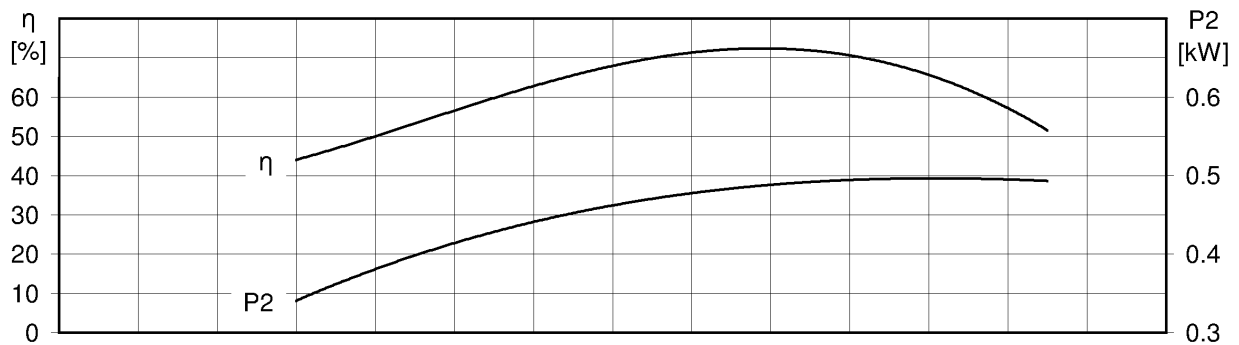
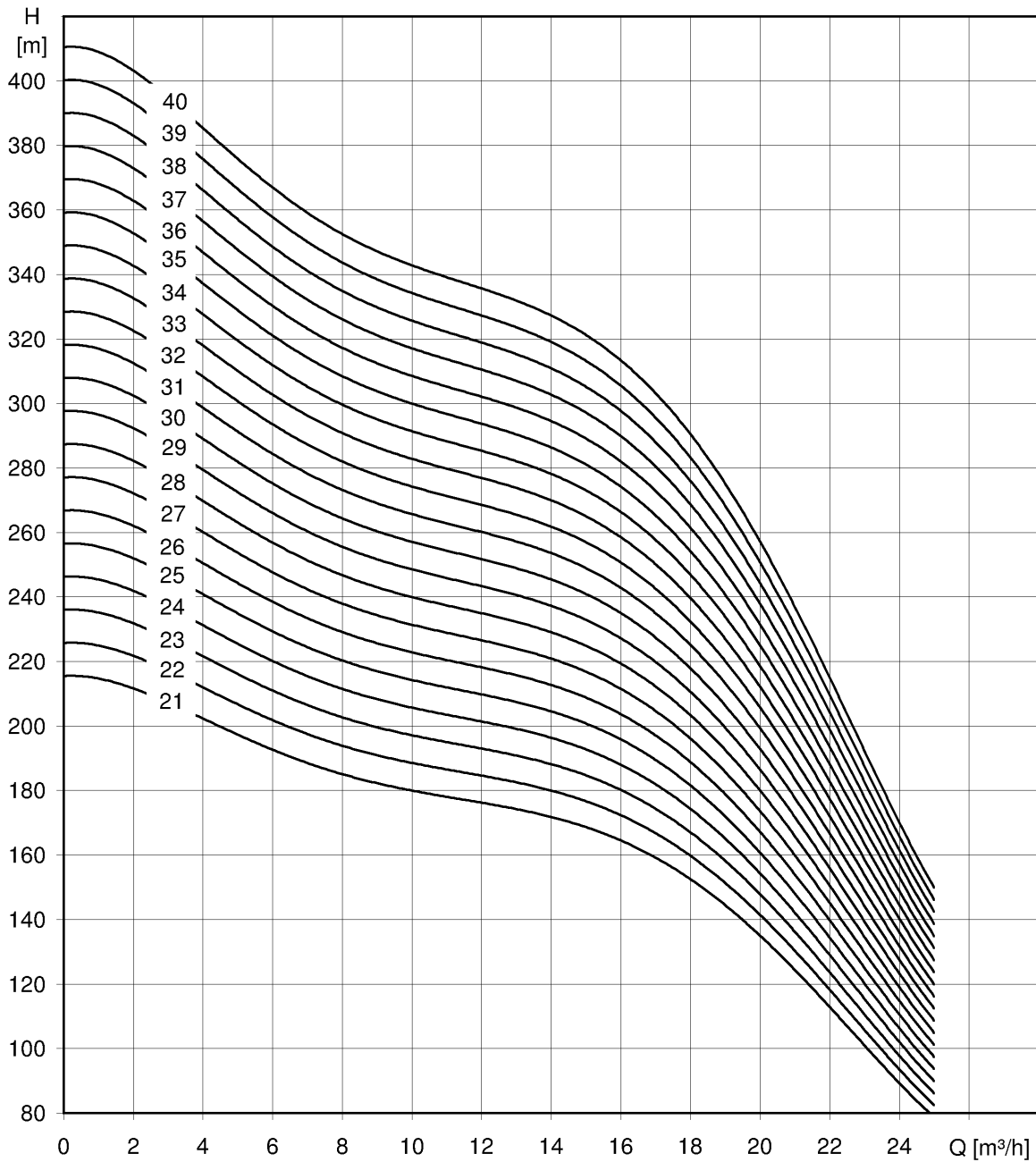

Änderungen vorbehalten

**po-so-16/6.5**  
2850 1/min - 50 Hz

Type	Leistung		Strom 400V [A]	Fördermenge Q								Länge l [mm]	Masse m [kg]	
	[kW]	[HP]		[l/s]	1.7	2.5	3.3	4.4	4.7	5.6	6.1			6.9
				[m³/h]	6	9	12	16	17	20	22			25
po-so-16-21/6.5	11	15	24	Förderhöhe H [m]	193	183	175	166	159	133	114	79	2115	84
po-so-16-22/6.5	13	17.5	29		202	191	184	174	166	140	120	82	2189	88
po-so-16-23/6.5	13	17.5	29		211	200	192	182	174	146	125	86	2228	89
po-so-16-24/6.5	13	17.5	29		220	209	200	190	182	152	130	90	2267	90
po-so-16-25/6.5	13	17.5	29		229	217	209	198	189	159	136	93	2345	91
po-so-16-26/6.5	15	20	32		239	226	217	206	197	165	141	97	2434	97
po-so-16-27/6.5	15	20	32		248	235	225	214	204	171	147	101	2473	98
po-so-16-28/6.5	15	20	32		257	243	234	222	212	178	152	105	2512	98
po-so-16-29/6.5	15	20	32		266	252	242	229	219	184	158	108	2551	99
po-so-16-30/6.5	18.5	25	40		275	261	250	237	227	190	163	112	2655	107
po-so-16-31/6.5	18.5	25	40		284	270	259	245	235	197	168	116	2694	108
po-so-16-32/6.5	18.5	25	40		294	278	267	253	242	203	174	120	2733	109
po-so-16-33/6.5	18.5	25	40		303	287	275	261	250	209	179	123	2772	110
po-so-16-34/6.5	18.5	25	40		312	296	284	269	257	216	185	127	2811	111
po-so-16-35/6.5	18.5	25	40		321	304	292	277	265	222	190	131	2850	111
po-so-16-36/6.5	18.5	25	40		330	313	301	285	272	229	196	135	2889	112
po-so-16-37/6.5	22	30	48		339	322	309	293	280	235	201	138	3003	120
po-so-16-38/6.5	22	30	48		349	330	317	301	287	241	207	142	3042	121
po-so-16-39/6.5	22	30	48		358	339	326	309	295	248	212	146	3081	122
po-so-16-40/6.5	22	30	48		367	348	334	317	303	254	217	150	3120	123

Mindesteffizienzindex MEI ≥ 0.4

Änderungen vorbehalten

**po-so-25/6.5**  
2850 1/min - 50 Hz

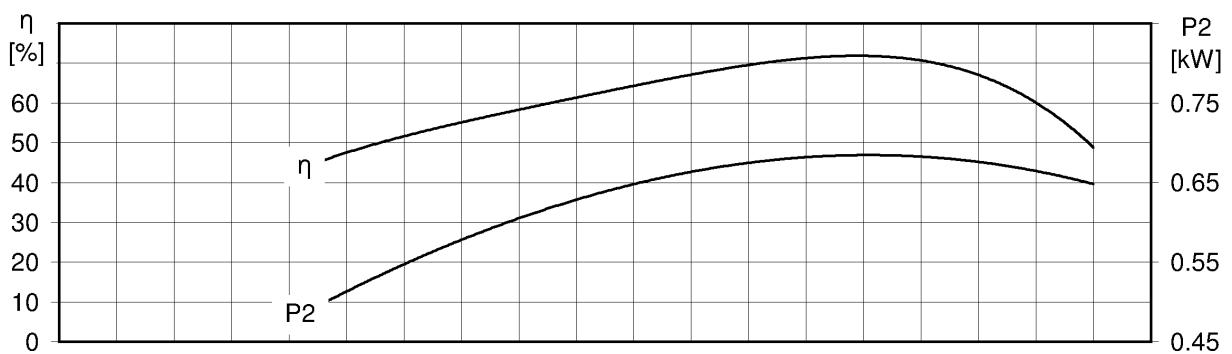
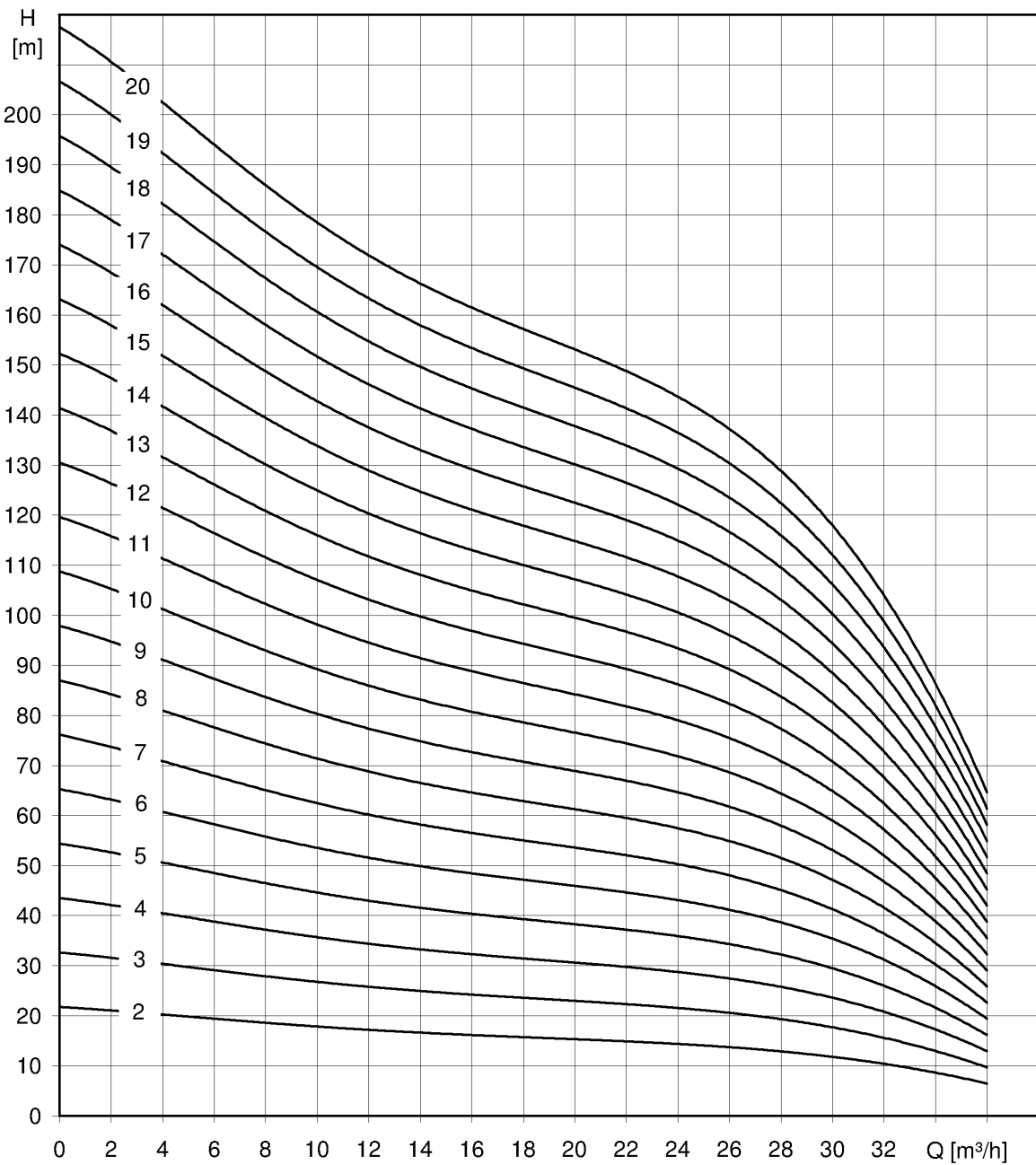

Änderungen vorbehalten

**po-so-25/6.5**  
2850 1/min - 50 Hz

Type	Leistung		Strom 400V [A]	Fördermenge Q										Länge l [mm]	Masse m [kg]
	[kW]	[HP]		[l/s]	2.5	4.2	5.6	6.4	6.9	7.5	8.3	10			
				[m³/h]	9	15	20	23	25	27	30	36			
po-so-25- 2/6.5	2.2*	3*	5.9	Förderhöhe H [m]	18	17	15	14	14	14	12	6	943	21	
po-so-25- 3/6.5	2.2*	3*	5.9		27	25	23	22	21	20	17	10	992	22	
po-so-25- 4/6.5	3*	4*	8.3		36	33	30	29	28	27	23	13	1192	30	
po-so-25- 5/6.5	4*	5.5*	10		45	41	38	36	36	34	29	16	1311	34	
po-so-25- 6/6.5	5.5*	7.5*	14		54	50	45	43	43	41	35	19	1430	39	
po-so-25- 7/6.5	5.5*	7.5*	14		64	58	53	51	50	48	41	23	1479	40	
po-so-25- 8/6.5	7.5	10	17		73	66	60	58	57	54	46	26	1573	62	
po-so-25- 9/6.5	7.5	10	17		82	75	68	65	64	61	52	29	1622	63	
po-so-25-10/6.5	7.5	10	17		91	83	76	72	71	68	58	32	1671	64	
po-so-25-11/6.5	9.2	12.5	21		100	91	83	80	78	75	64	36	1760	69	
po-so-25-12/6.5	9.2	12.5	21		109	99	91	87	85	82	70	39	1809	70	
po-so-25-13/6.5	9.2	12.5	21		118	108	98	94	92	88	75	42	1858	71	
po-so-25-14/6.5	11	15	24		127	116	106	101	99	95	81	45	1992	80	
po-so-25-15/6.5	11	15	24		136	124	113	109	107	102	87	49	2041	81	
po-so-25-16/6.5	13	17.5	29		145	132	121	116	114	109	93	52	2125	86	
po-so-25-17/6.5	13	17.5	29		154	141	129	123	121	116	99	55	2174	87	
po-so-25-18/6.5	13	17.5	29		163	149	136	130	128	122	104	58	2223	88	
po-so-25-19/6.5	15	20	32		173	157	144	138	135	129	110	62	2322	94	
po-so-25-20/6.5	15	20	32		182	166	151	145	142	136	116	65	2371	95	

\* 4"-Motor

Mindesteffizienzindex MEI ≥ 0.4

Änderungen vorbehalten

**po-so-25/6.5**  
2850 1/min - 50 Hz

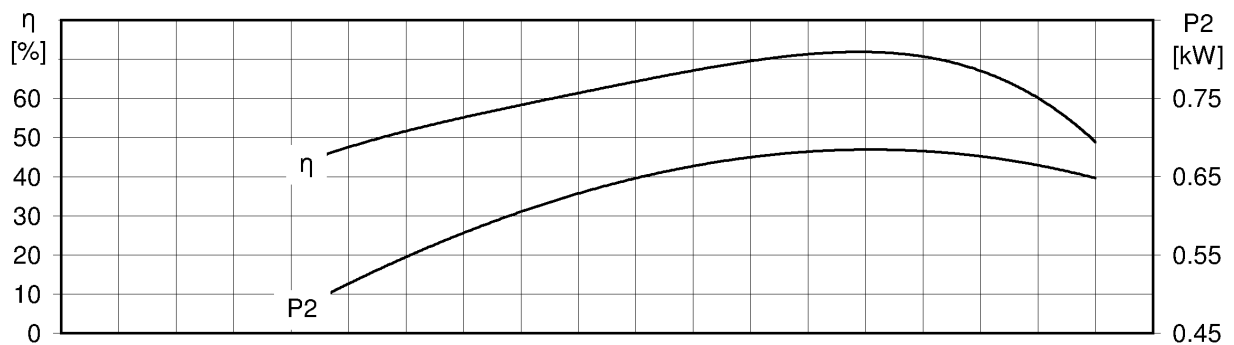
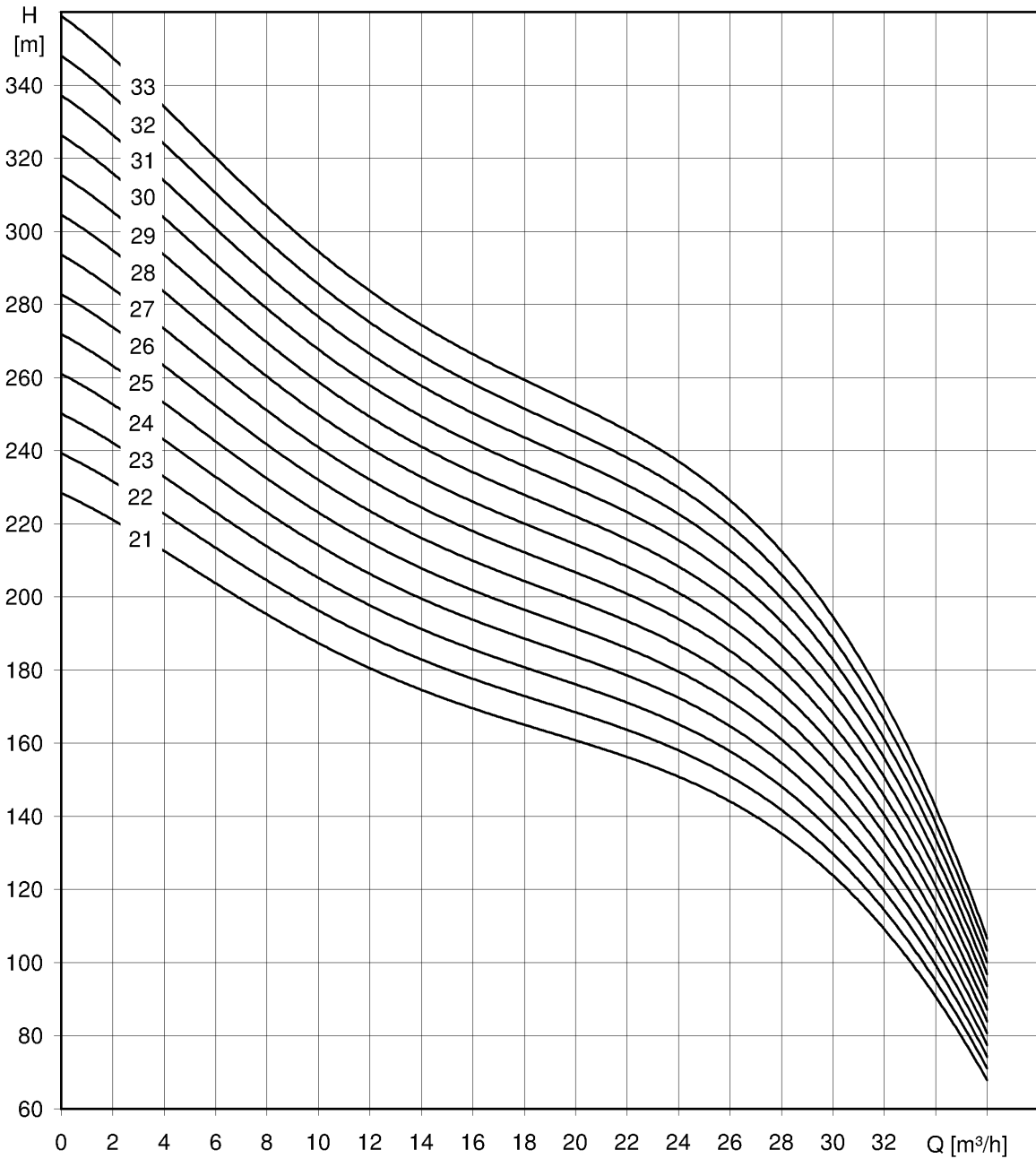

Änderungen vorbehalten

**po-so-25/6.5**  
2850 1/min - 50 Hz

Type	Leistung [kW] [HP]		Strom 400V [A]	Fördermenge Q										Länge l [mm]	Masse m [kg]
				[l/s]	2.5	4.2	5.6	6.4	<b>6.9</b>	7.5	8.3	10			
				[m³/h]	9	15	20	23	<b>25</b>	27	30	36			
<b>po-so-25-21/6.5</b>	15	20	32	Förderhöhe H [m]	191	174	159	152	<b>149</b>	143	122	68	2420	96	
<b>po-so-25-22/6.5</b>	18.5	25	40		200	182	166	159	<b>156</b>	150	128	71	2534	104	
<b>po-so-25-23/6.5</b>	18.5	25	40		209	190	174	167	<b>163</b>	156	133	75	2583	105	
<b>po-so-25-24/6.5</b>	18.5	25	40		218	199	181	174	<b>170</b>	163	139	78	2632	106	
<b>po-so-25-25/6.5</b>	18.5	25	40		227	207	189	181	<b>178</b>	170	145	81	2730	107	
<b>po-so-25-26/6.5</b>	18.5	25	40		236	215	197	188	<b>185</b>	177	151	84	2779	108	
<b>po-so-25-27/6.5</b>	22	30	48		245	224	204	195	<b>192</b>	184	157	87	2903	116	
<b>po-so-25-28/6.5</b>	22	30	48		254	232	212	203	<b>199</b>	190	162	91	2952	117	
<b>po-so-25-29/6.5</b>	22	30	48		263	240	219	210	<b>206</b>	197	168	94	3001	118	
<b>po-so-25-30/6.5</b>	22	30	48		272	248	227	217	<b>213</b>	204	174	97	3050	119	
<b>po-so-25-31/6.5</b>	22	30	48		281	257	234	224	<b>220</b>	211	180	100	3099	120	
<b>po-so-25-32/6.5</b>	22	30	48		291	265	242	232	<b>227</b>	218	186	104	3148	121	
<b>po-so-25-33/6.5</b>	26	35	57		300	273	249	239	<b>234</b>	224	191	107	3267	128	

Mindesteffizienzindex MEI  $\geq$  0.4

Änderungen vorbehalten

**po-so-40/6.5**  
2850 1/min - 50 Hz

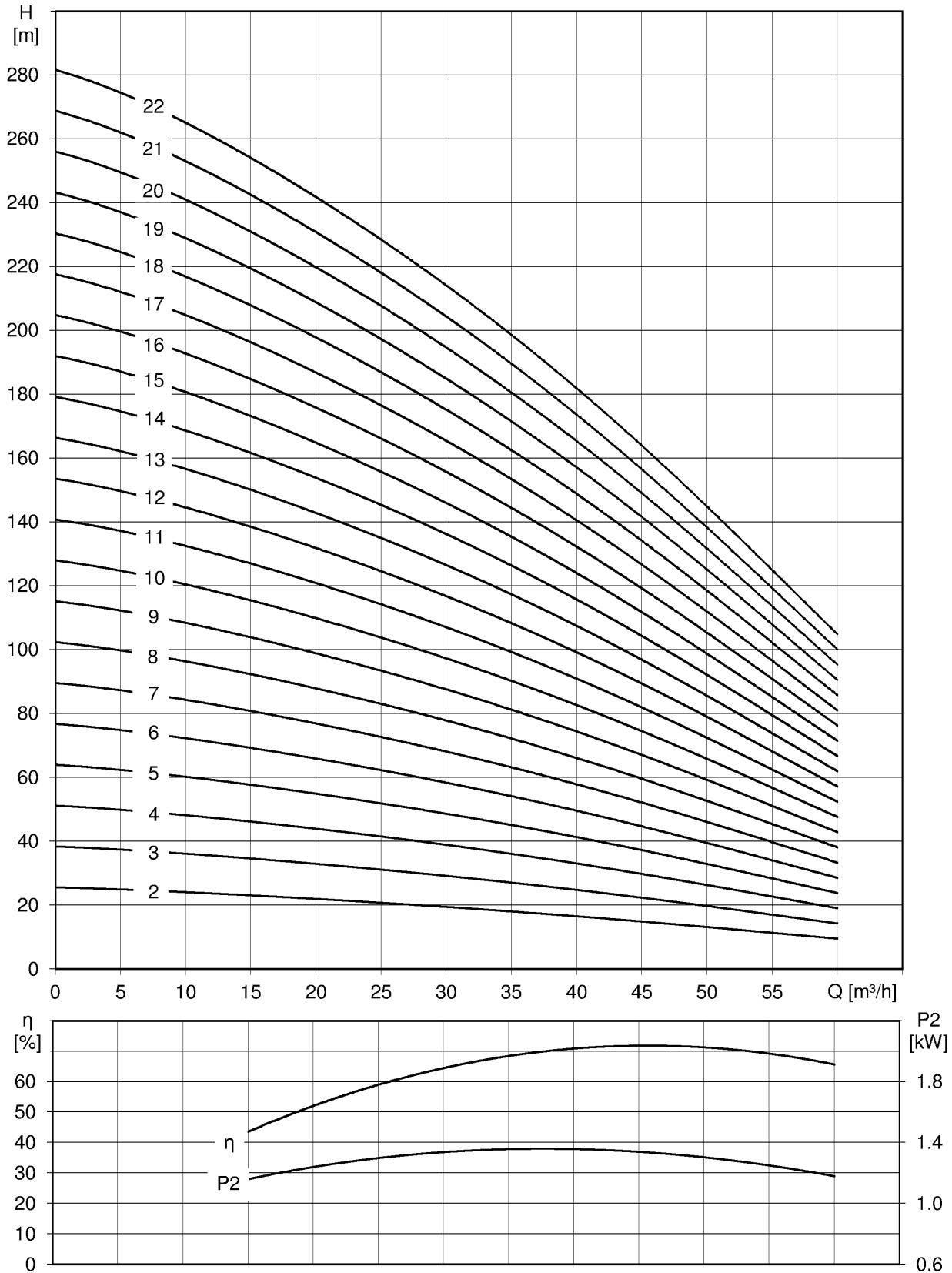

Änderungen vorbehalten

**po-so-40/6.5**  
2850 1/min - 50 Hz

Type	Leistung		Strom 400V [A]	Fördermenge Q									Länge l [mm]	Masse m [kg]
	[kW]	[HP]		[l/s]	4.2	8.3	10	11.1	12.5	13.9	15.3	16.7		
				[m³/h]	15	30	36	40	45	50	55	60		
po-so-40- 2/6.5	3*	4*	8.3	Förderhöhe H [m]	23	19	18	17	15	13	11	10	1174	31
po-so-40- 3/6.5	5.5*	7.5*	14		35	29	27	25	22	20	17	14	1425	40
po-so-40- 4/6.5	7.5	10	17		46	39	36	33	30	26	23	19	1581	63
po-so-40- 5/6.5	7.5	10	17		58	49	44	42	37	33	29	24	1692	64
po-so-40- 6/6.5	9.2	12.5	21		69	58	53	50	44	40	34	29	1843	70
po-so-40- 7/6.5	11	15	24		81	68	62	58	52	46	40	33	2039	79
po-so-40- 8/6.5	13	17.5	29		92	78	71	67	59	53	46	38	2185	85
po-so-40- 9/6.5	13	17.5	29		104	87	80	75	67	59	51	43	2296	86
po-so-40-10/6.5	15	20	32		116	97	89	83	74	66	57	48	2457	93
po-so-40-11/6.5	18.5	25	40		127	107	98	92	81	72	63	52	2633	101
po-so-40-12/6.5	18.5	25	40		139	117	107	100	89	79	68	57	2744	103
po-so-40-13/6.5	18.5	25	40		150	126	116	108	96	86	74	62	2855	104
po-so-40-14/6.5	22	30	48		162	136	124	116	103	92	80	67	3041	113
po-so-40-15/6.5	22	30	48		173	146	133	125	111	99	86	71	3152	114
po-so-40-16/6.5	26	35	57		185	155	142	133	118	105	91	76	3333	122
po-so-40-17/6.5	26	35	57		196	165	151	141	126	112	97	81	3444	123
po-so-40-18/6.5	26	35	57		208	175	160	150	133	119	103	86	3555	125
po-so-40-19/6.5	30	40	64		219	184	169	158	140	125	108	90	3776	134
po-so-40-20/6.5	30	40	64		231	194	178	166	148	132	114	95	3887	136
po-so-40-21/6.5	30	40	64		243	204	187	175	155	138	120	100	3998	137
po-so-40-22/6.5	34	45	71	254	214	196	183	163	145	125	105	4159	143	

\* 4"-Motor

Mindesteffizienzindex MEI ≥ 0.4

Änderungen vorbehalten



**po-so-63/6.5**  
2850 1/min - 50 Hz

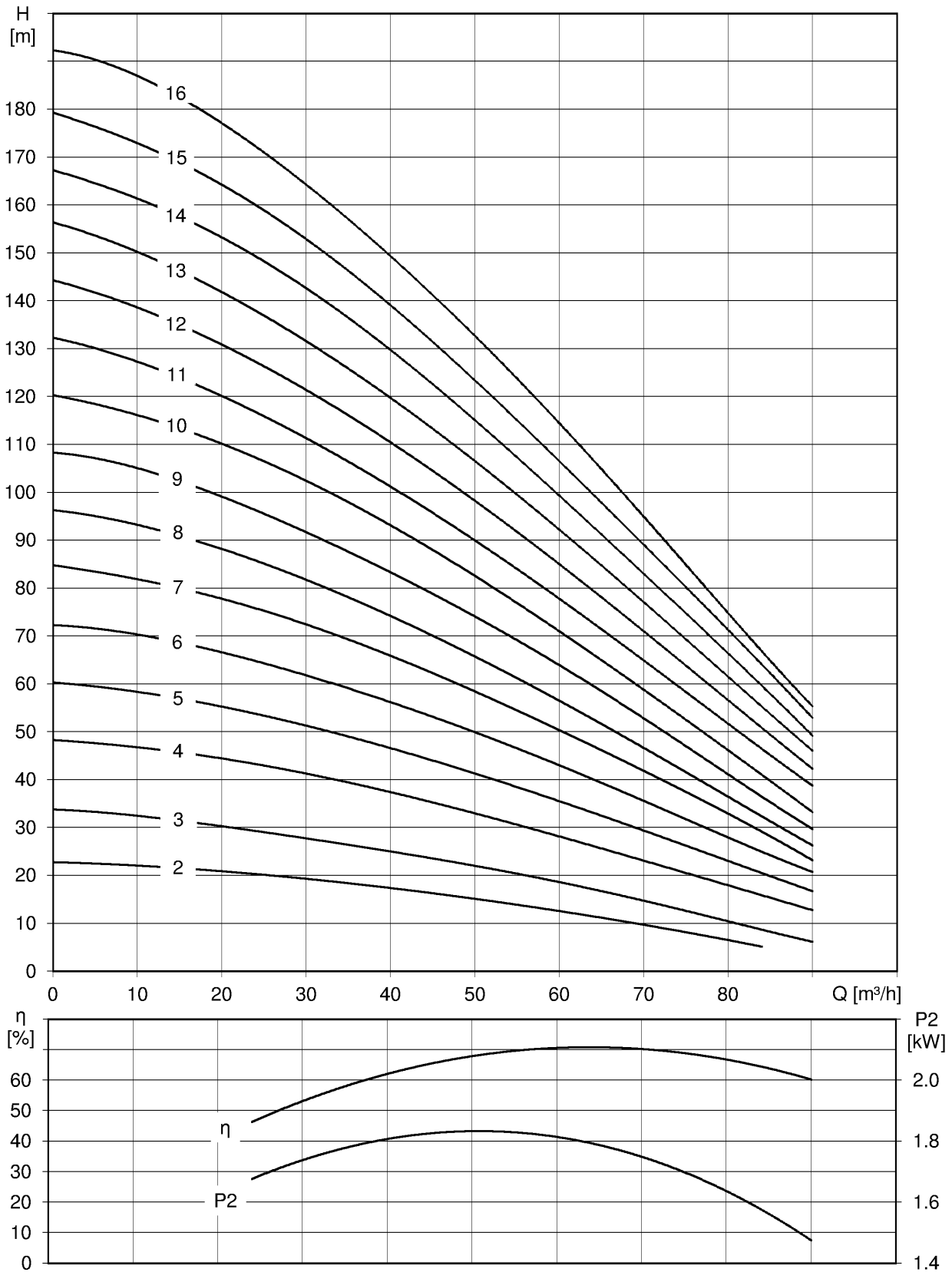

Änderungen vorbehalten

**po-so-63/6.5**  
2850 1/min - 50 Hz

Type	Leistung		Strom 400V [A]	Fördermenge Q									Länge l [mm]	Masse m [kg]	
	[kW]	[HP]		[l/s]	6.7	11.7	15	17.5	20	21.7	23.3	25			
				[m³/h]	24	42	54	63	72	78	84	90			
<b>po-so-63- 2/6.5</b>	4*	5.5*	10	Förderhöhe H [m]	20	17	14	12	9	7	5		1244	35	
<b>po-so-63- 3/6.5</b>	5.5*	7.5*	14		29	25	21	17	14	11	9	6		1425	40
<b>po-so-63- 4/6.5</b>	7.5	10	17		43	37	31	27	22	19	16	13		1581	63
<b>po-so-63- 5/6.5</b>	9.2	12.5	21		54	46	39	34	28	24	21	17		1732	69
<b>po-so-63- 6/6.5</b>	11	15	24		65	55	47	41	34	29	25	21		1928	78
<b>po-so-63- 7/6.5</b>	13	17.5	29		76	65	55	48	40	35	29	23		2074	83
<b>po-so-63- 8/6.5</b>	15	20	32		86	73	62	54	45	38	33	26		2235	90
<b>po-so-63- 9/6.5</b>	18.5	25	40		96	82	70	61	51	43	37	30		2411	98
<b>po-so-63-10/6.5</b>	18.5	25	40		107	91	78	67	56	49	41	33		2522	100
<b>po-so-63-11/6.5</b>	22	30	48		117	99	85	74	62	54	47	39		2708	108
<b>po-so-63-12/6.5</b>	22	30	48		127	108	93	81	68	59	51	42		2819	109
<b>po-so-63-13/6.5</b>	26	35	57		138	117	101	88	74	64	56	46		3000	117
<b>po-so-63-14/6.5</b>	26	35	57		149	127	109	95	80	70	60	49		3111	118
<b>po-so-63-15/6.5</b>	30	40	64		160	136	117	102	85	75	64	53		3332	128
<b>po-so-63-16/6.5</b>	30	40	64		172	146	126	109	91	79	67	55		3443	129

\* 4"-Motor

Mindesteffizienzindex MEI ≥ 0.4

Änderungen vorbehalten

**Spezifikation**

- mehrstufige Kreiselpumpe in Gliederbauweise mit **oddesse** Tauchmotor
- Druckabgang mit integriertem Rückschlagventil
- Antrieb durch Drehstrom-Motoren
- minimale Wasserüberdeckung des Pumpenaggregates 2 m
- min. Strömungsgeschwindigkeit entlang des Motors 0.5 m/s, max. Temperatur des Mediums von 30 °C
- reines, sauberes Wasser mit festen Beimengungen bis max. 50 mg/l
- Standardanschluss: R = G3 (Rohrgewinde nach DIN ISO 228 Teil 1)
- andere Anschlüsse als Zubehör lieferbar
- Abnahme nach DIN EN ISO 9906 Klasse 2
- Sonderausführungen (Horizontaleinsatz u.s.w.) auf Anfrage
- Mindesteffizienzindex MEI ≥ 0.4

**Hauptabmessungen**

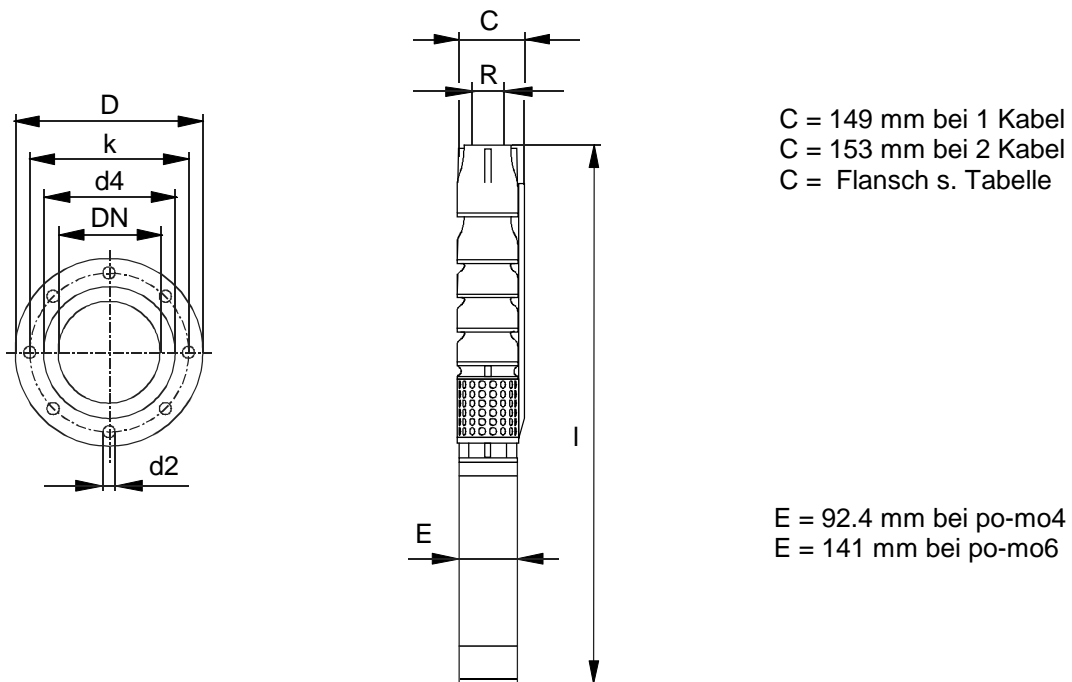

**Anschlussmaße für Adapter und Übergänge**

Type	Reduzierung Gewinde	Adapter						
		Gewinde ⇒ Flansch	Abmessungen					
			D [mm]	b [mm]	k [mm]	d4 [mm]	d2 [mm]	m [kg]
po-so-63/6.4	G3 ⇒ G2	G3 ⇒ DN50, PN16	165	18	125	102	4x ø18	3.5
		G3 ⇒ DN50, PN40	165	20	125	102	4x ø18	3.7
		G3 ⇒ DN65, PN16	185	18	145	122	4x ø18	4.1
		G3 ⇒ DN65, PN40	185	22	145	122	8x ø18	4.3
		G3 ⇒ DN80, PN16	200	20	160	138	8x ø18	4.7
		G3 ⇒ DN80, PN40	200	24	160	138	8x ø18	5.7
		G3 ⇒ DN100, PN16	220	20	180	158	8x ø18	6.1
		G3 ⇒ DN100, PN40	235	24	190	162	8x ø22	8.0

Flanschabmessungen nach DIN 2633 (PN16) und DIN 2635 (PN40)  
 Materialausführung verzinkt oder Edelstahl  
 PN Nenndruck [bar], DN Nenndurchmesser [mm], b Flanschdicke [mm], m Masse [kg]  
 Flansche mit je 2 Kabelaussparungen

Änderungen vorbehalten

## Konstruktionsmaterialien

### Tauchmotorpumpen po-so/6.4

Komponente	Ausführung	
	Standard-Version	L-Version
Laufrad	GG25 / 0.6025	CuSn10 / 2.1050
Stufengehäuse	GG25 / 0.6025	
Einlaufstück	GG25 / 0.6025	
Druckstutzen, RV-Gehäuse	GG25 / 0.6025	
Radiallager	Gummi / Edelstahl	
Einlaufsieb	Edelstahl / 1.4301	
Kupplung	Edelstahl / 1.4005	
Welle	Edelstahl / 1.4021	
Schrauben, Muttern, Bolzen	Edelstahl A2 1.4301 / 1.4303	
Motor	siehe Abschnitt Tauchmotoren	

### Anmerkung:

Der Mindesteffizienzindex (MEI) bezieht sich auf den vollen Laufraddurchmesser. Alle Pumpen dieser Serie gelangen werksseitig ausschließlich mit vollem Laufrad zur Auslieferung.

Durch eine Korrektur des Laufrades kann die Pumpe einem bestimmtem Betriebspunkt angepasst werden, wodurch sich der Energieverbrauch verringert. Der Wirkungsgrad einer Pumpe mit korrigiertem Laufrad ist gewöhnlich niedriger als der einer Pumpe mit vollem Laufraddurchmesser.

Der Betrieb dieser Wasserpumpe bei unterschiedlichen Betriebspunkten kann effizienter und wirtschaftlicher sein, wenn sie z. B. mittels einer variablen Drehzahlsteuerung gesteuert wird, die den Pumpenbetrieb an das System anpasst.

Informationen zum Effizienzreferenzwert sind unter [www.europump.org](http://www.europump.org) abrufbar, Referenzwertkurven sind unter [www.europump.org/efficiencycharts](http://www.europump.org/efficiencycharts) verfügbar.

Änderungen vorbehalten

**po-so-63/6.4**  
2850 1/min - 50 Hz

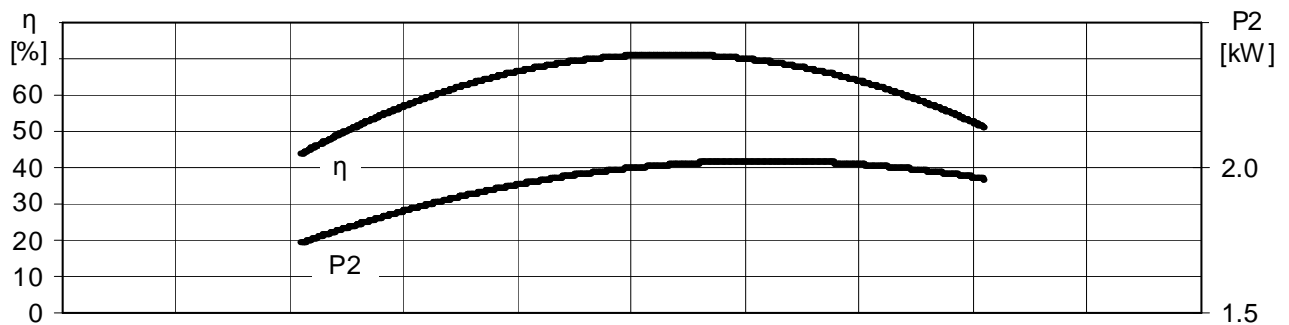
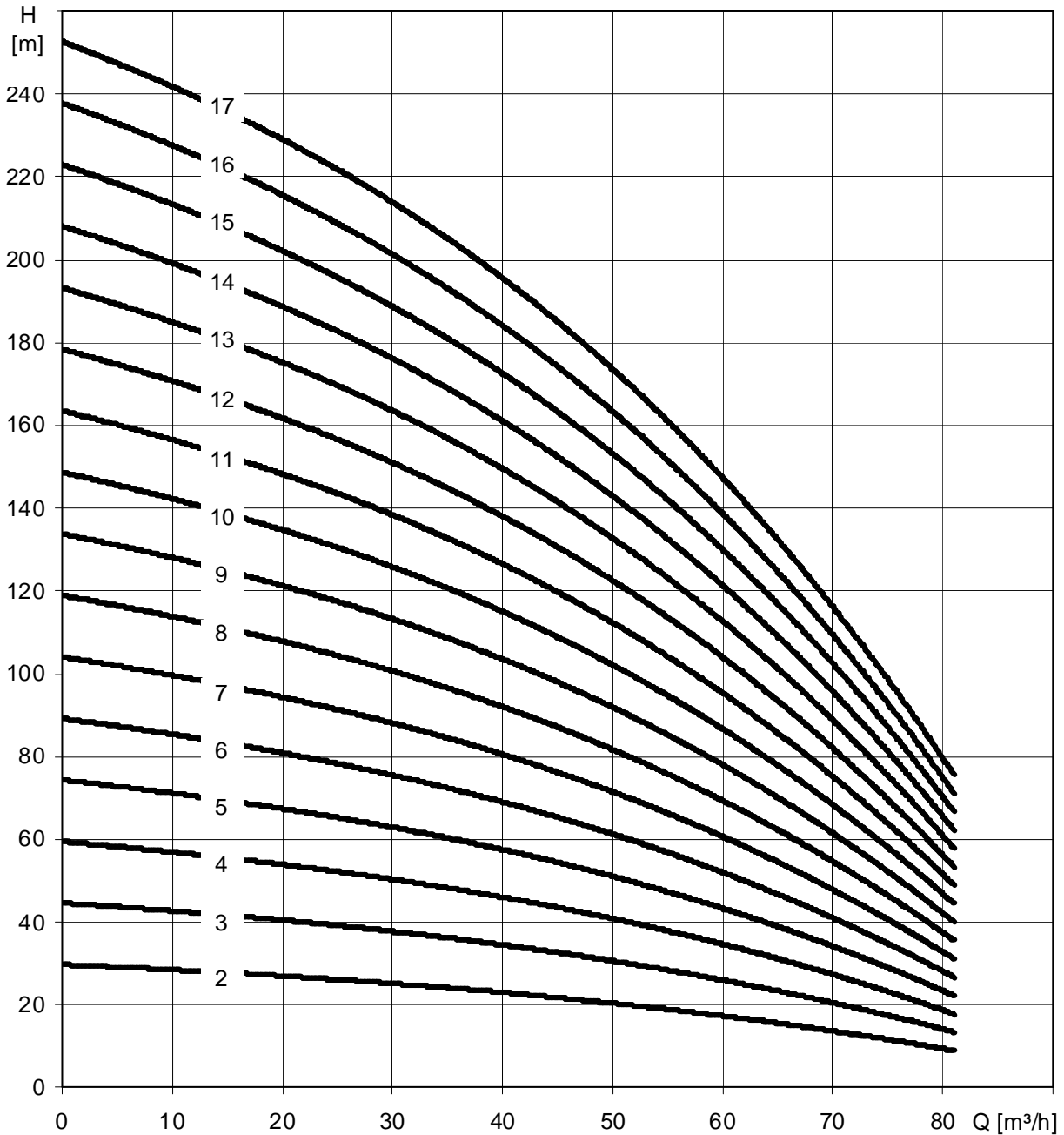

Änderungen vorbehalten

**po-so-63/6.4**  
2850 1/min - 50 Hz

Type	Leistung P [kW]	Strom 400V [A]	Fördermenge Q									Länge l [mm]	Masse m [kg]
			[l/s]	6	14	16	18	18	20	21	23		
			[m³/h]	21	51	57	63	66	72	75	81		
po-so-63- 2/6.4	5.5	14	Förderhöhe H [m]	27	20	18	16	15	13	12		1298	53
po-so-63- 3/6.4	7.5	17		40	30	27	24	23	19	17		1449	81
po-so-63- 4/6.4	9.2	21		54	40	37	33	31	26	23	18	1592	90
po-so-63- 5/6.4	11	24		67	50	46	41	39	32	29	22	1779	103
po-so-63- 6/6.4	13	29		81	60	55	49	46	39	35	27	1917	112
po-so-63- 7/6.4	15	32		94	70	64	57	54	45	41	31	2069	122
po-so-63- 8/6.4	18.5	40		107	80	73	65	62	51	46	35	2237	134
po-so-63- 9/6.4	22	48		121	90	82	73	69	58	52	40	2414	146
po-so-63-10/6.4	22	48		134	100	91	81	77	64	58	44	2517	151
po-so-63-11/6.4	26	57		148	110	101	90	85	71	64	49	2689	162
po-so-63-12/6.4	26	57		161	120	110	98	93	77	69	53	2792	167
po-so-63-13/6.4	30	64		175	130	119	106	100	84	75	58	3004	180
po-so-63-14/6.4	30	64		188	140	128	114	108	90	81	62	3107	185
po-so-63-15/6.4	34	71		201	150	137	122	116	96	87	66	3259	194
po-so-63-16/6.4	34	71		215	160	146	130	123	103	93	71	3362	199
po-so-63-17/6.4	37	78		228	170	155	138	131	109	98	75	3544	209

Mindesteffizienzindex MEI  $\geq$  0.4

Änderungen vorbehalten